

PCM-1P SERIES USER MANUAL

PHASE ANGLE SCR DRIVER BOARD

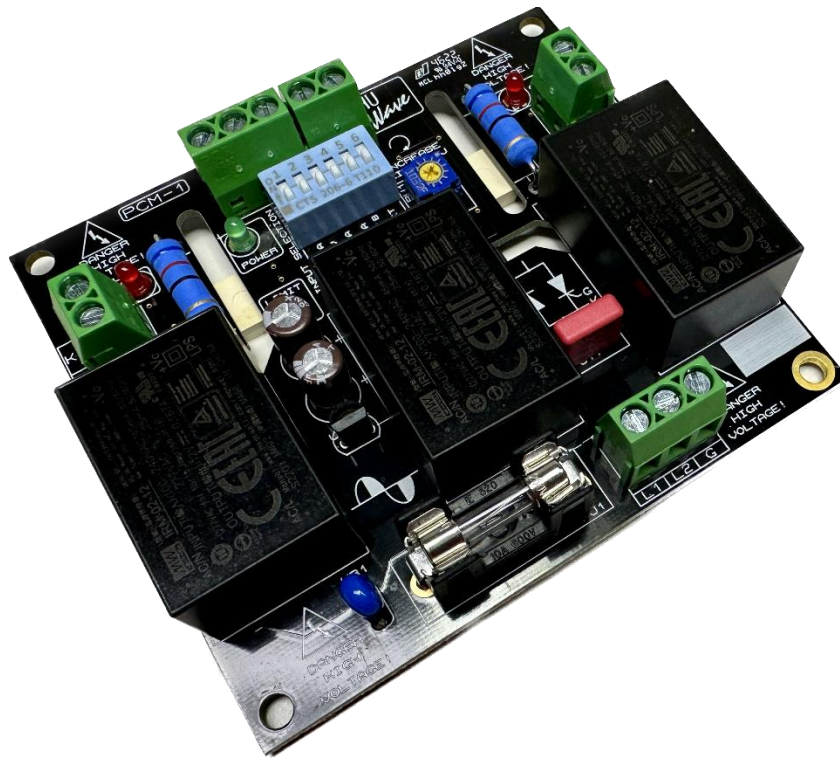
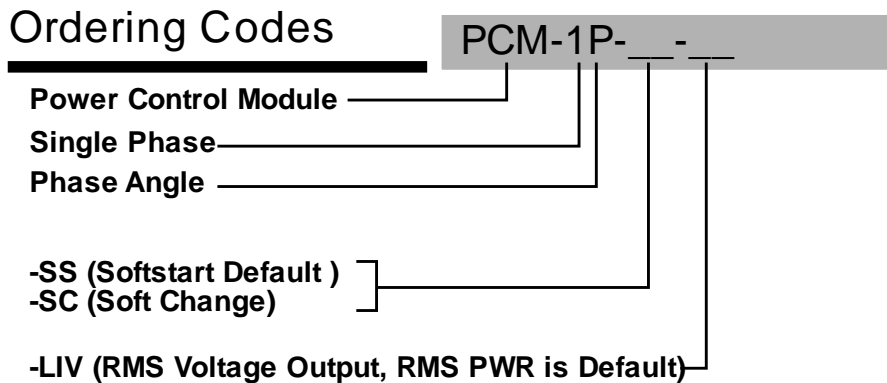

TABLE OF CONTENTS

1.	Ordering Codes.....	3
2.	Description	3
3.	Installation / Safety Information.....	4
3.1	Mounting Instructions.....	4
3.2	Electrical Connections	4
3.3	SCR Output Snubbers and Transient Protection	4
3.3.1	Commutation Problems	4
3.3.2	dv/dt Problems.....	4
3.3.3	Snubber Sizing	5
3.3.4	MOVs and TVSs.....	5
3.4	Limited Warranty.....	5
4.	Operation	5
4.1	Power Supply.....	5
4.2	Power Fusing.....	5
4.3	Command Input	5
4.3.1	PWM Command Input.....	6
4.3.2	Input Fail-safe Protection	6
4.3.3	Current Limit & Soft Change	6
4.4	Soft Start.....	6
4.1	Soft Change	7
4.2	Voltage Limit	7
4.3	Current Feedback / Current Limit.....	7
4.3.1	Current Transformer Input	7
4.4	Configuration Dipswitch	7
4.5	Indicator LEDs	8
4.5.1	Power LED.....	8
4.5.2	SCR Drive LEDs	8
4.5.3	Current Limit LED	8
4.6	Three Phase Operation.....	8
5.	Electrical Specifications	9
5.1	SCR Gate Drive Profile	9
5.2	Input Specifications.....	9
5.3	Output Specifications	9
5.3.1	Mechanical Dimensions.....	10
6.	WIRING DIAGRAM - SINGLE PHASE.....	11
7.	Contact Information.....	11

1. Ordering Codes



2. Description

The PCM-1P is a Phase Angle SCR Power Control Driver Board designed for use with high power back to back SCR modules driving resistive or inductive loads. The power delivered to the load is proportional to the command input signal. The gate drive technique used in the PCM-1P is DC drive for the reliable firing of inductive loads.

Features:

- Back to Back SCR Driver provides DC gate drive
- Linear output phase angle control w/current feed back
- Suitable for resistive or Inductive Loads
- Inputs of 4-20mA, 0-20mA, 0-10V, 2-10V, 0-5V, 1-5V, Pot, PWM
- Configurable soft start / change for high inrush loads
- Automatic 50/60Hz and 120/208/240VAC operation
- Adjustable voltage and current limit
- LED power and output indicators

3. Installation / Safety Information

Responsibility for determining suitability for use in any application / equipment lies solely on the purchaser, OEM and end user. Suitability for use in your application is determined by applicable standards such as UL, cUL and CE and the completed system involving this component should be tested to those standards.



WARNING: FIRE HAZARD!! Even quality electronic components **CAN FAIL KEEPING FULL POWER ON!** Provide a **SEPARATE (redundant) OVER TEMPERATURE SHUTDOWN DEVICE** to switch the power off if safe temperatures are exceeded.



WARNING: HIGH VOLTAGE!! This control board has high voltage on it that can cause death. This control must be installed in a **GROUNDED** enclosure by a qualified electrician in accordance with applicable local and national codes including NEC and other applicable codes. Provide a safety interlock on the door to remove power before gaining access to the device.

3.1 Mounting Instructions

The PCM-1P mounts using four #6 screws. See the mechanical dimensions section for more details. The PCB should be mounted at least 0.500" from any surface.

3.2 Electrical Connections

See the **WIRING DIAGRAMS** at the end of this document. Make sure the unit ordered is the correct unit for the application before wiring. Before wiring the unit, all Dip Switch settings for the command input and special features should be setup properly per the Dipswitch Configuration Section.

3.3 SCR Output Snubbers and Transient Protection

3.3.1 Commutation Problems

When an SCR or TRIAC is used to control an inductive load, the load current lags the mains voltage. When the device turns off at zero current, the rate of rise of the reapplied voltage can retrigger the device and produce half cycling and blown fuses. To limit this rate of rise and obtain reliable commutation, an R-C (resistor-capacitor) snubber circuit should be connected in parallel with the SCR/TRIAC.

3.3.2 dv/dt Problems

When voltage transients occur on the mains supply or load of an SCR/TRIAC it can cause the device to turn on unexpectedly due to the fast rate of rise of voltage (dv/dt). This can result in false firing and half cycling of the load that can cause blown fuses when driving inductive loads. An R-C snubber circuit will help to limit the dv/dt seen by the device and will produce more reliable firing.

3.3.3 Snubber Sizing

When an SCR/TRIAC using an R-C snubber turns on, the capacitor is discharged through the resistor into the device resulting in high peak currents. It is critically important when sizing your snubber to make sure that the resistor value does not become so low that the ratings of the SCR/TRIAC are exceeded when the capacitor is discharged.

3.3.4 MOVs and TVSs

Metal Oxide Varistors and Transient Voltage Suppressors are both used on TRIACS/SCRs to “clamp” voltage spikes that can occur across the devices and damage them. Snubbers are not a substitute for MOVs/TVSs and vice versa. Snubbers and MOVs/TVs should be used together to get reliable performance and long life from the SCR/TRIAC application. External MOV must be installed across SCRs to limit peak voltages seen by the NWIPCM to ~ 850VDC.

3.4 Limited Warranty

NuWave Technologies, Inc. warrant this product to be free from defect in workmanship and materials for a period of one (1) year from the date of purchase.

1. Should unit malfunction, return it to the factory. If defective it will be repaired or replaced at no charge.
2. There are no user serviceable parts on this unit. This warranty is void if the unit shows evidence of being tampered with or subjected to excessive heat, moisture, corrosion or other misuse / misapplication.
3. Components which wear or damage with misuse are excluded, e.g. relays.
4. NuWave Technologies, Inc. shall not be responsible for any damage or losses however caused, which may be experienced as a result of the installation or use of this product. NuWave Technologies, Inc. liability for any breach of this agreement shall not exceed the purchase price paid E. & O.E.

4. Operation

4.1 Power Supply

The PCM-1P power supply requirement is 90-265VAC 47-63Hz. The line synchronization for the phase angle firing is derived from the power supply input.

4.2 Power Fusing

A 100mA user serviceable fuse is provided. Under normal circumstances this fuse should not open. If it opens, one of the following conditions may have caused it:

1. A large power line transient occurred.
2. The PCM-1P was wired incorrectly and excess voltage was applied.
3. The PCM-1P malfunctioned and requires service.

4.3 Command Input

The PCM-1P can accept 4-20mA, 0-20mA, 0-10V, 2-10V, 0-5V, 1-5V, Potentiometer and TTL PWM inputs. All analog commands are isolated from the power line and SCR drive outputs. The type of command input can be configured via the dipswitch. The default setting is 0-5V/potentiometer. Connecting the power to any part of the command input or SCR drive outputs will cause damage to the unit.

4.3.1 PWM Command Input

The PWM input is designed to accept a push-pull 5V/TTL level drive at a frequency of 1KHz-100KHz.

If the command is coming from the 5VDC SSR drive of a temperature / process controller, all of the command dipswitches should be set to off and a 1K resistor should be added in parallel with the command input. The output cycle time of the temperature / process controller should be set to as fast as possible (100 or 200mS max) and the 4 second **soft change** switch should be selected.

4.3.2 Input Fail-safe Protection

If the signal sent to the PCM-1P's command input becomes electrically open the control output will be forced to a low output power state.

4.3.3 Current Limit & Soft Change

The current limit can be used with soft change. If Current Limit and soft change are selected, the soft change time will be applied with current limit.

4.4 Soft Start

The Soft Start feature ramps up to the command value over the dip switch selected soft start period. The soft start time resets if the command value goes to zero (less than ~4% of the input range) or power is cycled. Soft start is useful on high inrush heaters such as Quartz, Molybdenum, Tungsten, or Graphite heaters.

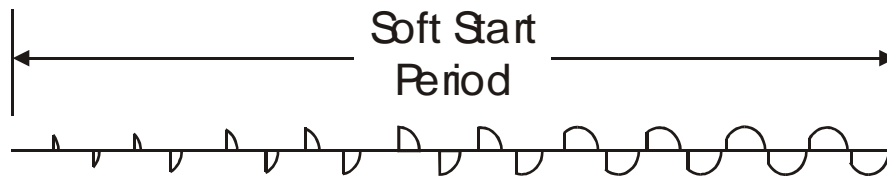

The Soft Start ramps the voltage up slowly over the soft start period.

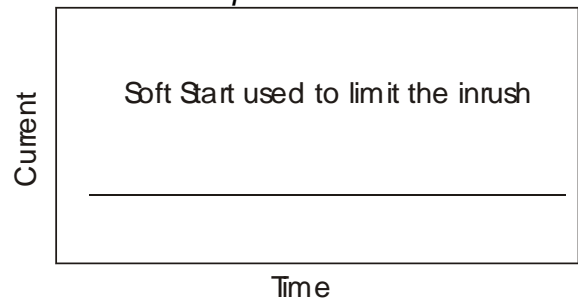
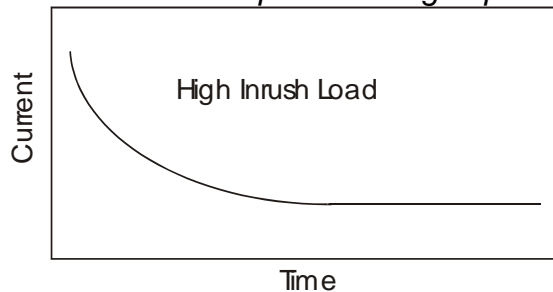

4.1 Soft Change

Soft change operates similarly to soft start except that soft change limits how quickly the output can increase or decrease. For inductive loads such as transformers, soft change is recommended because it prevents inrush current associated with DC accumulation and saturation of the transformer.

4.2 Voltage Limit

This feature will clip the command signal to a level set by the on-board potentiometer. The Voltage Limit is adjustable from 0% to 100% of the max load voltage. When the PCM-1P is actively holding back or “limiting” the command via voltage limit, the RED “LIMIT” LED will become energized.

4.3 Current Feedback / Current Limit

When the Current Limit feature is enabled and the current transformer wired per the Current Transformer Input section, the PCM-1 P will allow the maximum current to be set via the Current Limit Potentiometer. The range of adjustment of the Current Limit potentiometer is ~5 - 100% of full scale load current. The full scale load current is defined by the CT turns ratio described in the Current Transformer Input section below. When the PCM-1P is actively holding back or “limiting” the load current, the RED “LIM ON” LED will become energized.

4.3.1 Current Transformer Input

The PCM-1P requires a current transformer to be wired to the CT1 and CT2 terminals to provide current feedback for the Current Limit feature. If no current transformer is wired to the PCM-1P, it will operate normally, just without current feedback.

The CT input has a full scale of 200mA RMS, and 5V peak. For the best accuracy, the current transformer turns ratio should be chosen according to the maximum current of the controlled load as follows:

CT Turns Ratio	Max Measured Current (full scale load current)
1:500	100A RMS
1:1000	200A RMS
1:2000	400A RMS
1:4000	800A RMS
1:5000	1000A RMS

Other combinations of primary and secondary turns ratios may be used as long as the 200mA RMS and 5V peak of the CT input are not exceeded.

4.4 Configuration Dipswitch

The configuration dipswitch is used for setting up the command input, line soft start and limit as follows:

Command Input	2	3	4
0-5V (Default)	OFF	OFF	OFF
Potentiometer	OFF	OFF	OFF
0-10V	ON	OFF	OFF
4-20mA	OFF	ON	ON
1-5V	OFF	OFF	ON
2-10V	ON	OFF	ON

Feature	1	5	6
Soft Start / Soft Change OFF	OFF	OFF	
Soft Start / Soft Change 0.5 sec	ON	OFF	
Soft Start / Soft Change 1 sec	OFF	ON	
Soft Start / Soft Change 4 sec	ON	ON	
Voltage Limit			OFF
Current Limit			ON

4.5 Indicator LEDs

4.5.1 Power LED

The Green Power LED will illuminate when power is applied.

4.5.2 SCR Drive LEDs

The RED SCR Drive LEDs will turn on when the SCR drive output is on and increase in intensity as the phase angle power output is increased. If the SCR gate is not wired properly or not connected, the LED will not illuminate. The LED should only be used as a rough indication of SCR Drive and not actual power output.

4.5.3 Current Limit LED

The RED Current Limit LED will illuminate when the current limit is actively limiting the load current.

4.6 Three Phase Operation

Three PCM-1Ps can be used to control three poles of a three phase load for inside delta, or grounded WYE configurations.

5. Electrical Specifications

5.1 SCR Gate Drive Profile

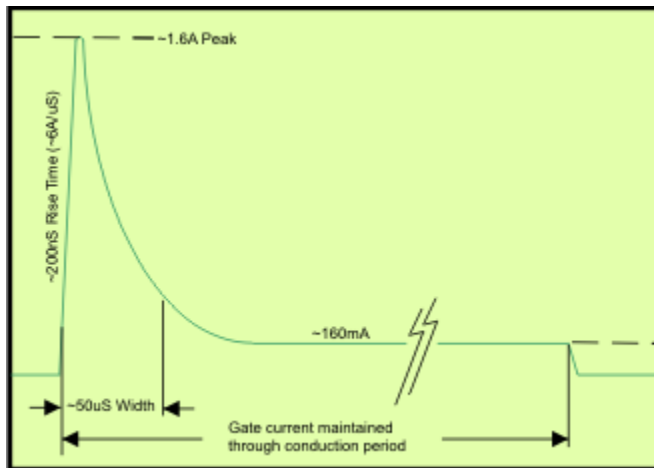

SCR Gate Drive Profile

5.2 Input Specifications

Command Inputs	4-20mA, 0-20mA, 0-10V, 2-10V, 0-5V, 1-5V, Pot, PWM
Input Impedance	10K Ω (0-10V), 250 Ω (4-20mA), 100K Ω (0-5V)
Response Time	<50mS
PWM Input Frequency	1KHz-100KHz
PWM Input Level	5 VDC TTL Level
CT Input Range	0-200mAAC (0-5VAC)
External Potentiometer Res.	1K Ω -25K Ω
Command to Mains Isolation	2500Vrms
Command to SCR Drive Isolation	2500Vrms

5.3 Output Specifications

Control Range	1 – 98% power
Output Linearity	+/-2%
Soft Start / Soft Change Period	0.5, 1, 4 seconds to reach 100% output
Current Limit Range	5-100%
Voltage Limit Range	0-100% of max load voltage
Ambient Temperature Range	0 to 50 $^{\circ}$ C
Power Supply	100-265VAC 50mA max.
Line Frequency Range	47 to 63Hz
SCR Gate Drive Characteristics	Initial pulse peak current of 1.6A rise time of ~200nS, maintain current of 160mA; See the SCR gate drive profile section for more detail.
SCR Drive / Mains Isolation	2500Vrms

5.3.1 Mechanical Dimensions

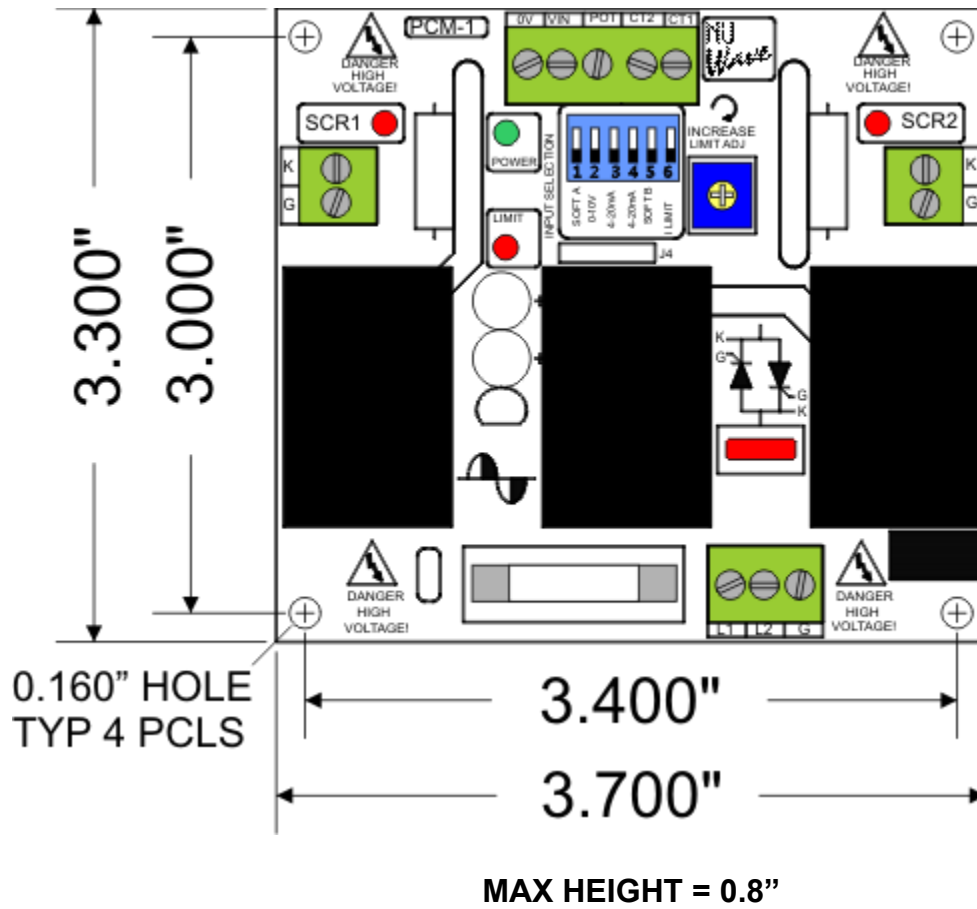

6. WIRING DIAGRAM - SINGLE PHASE

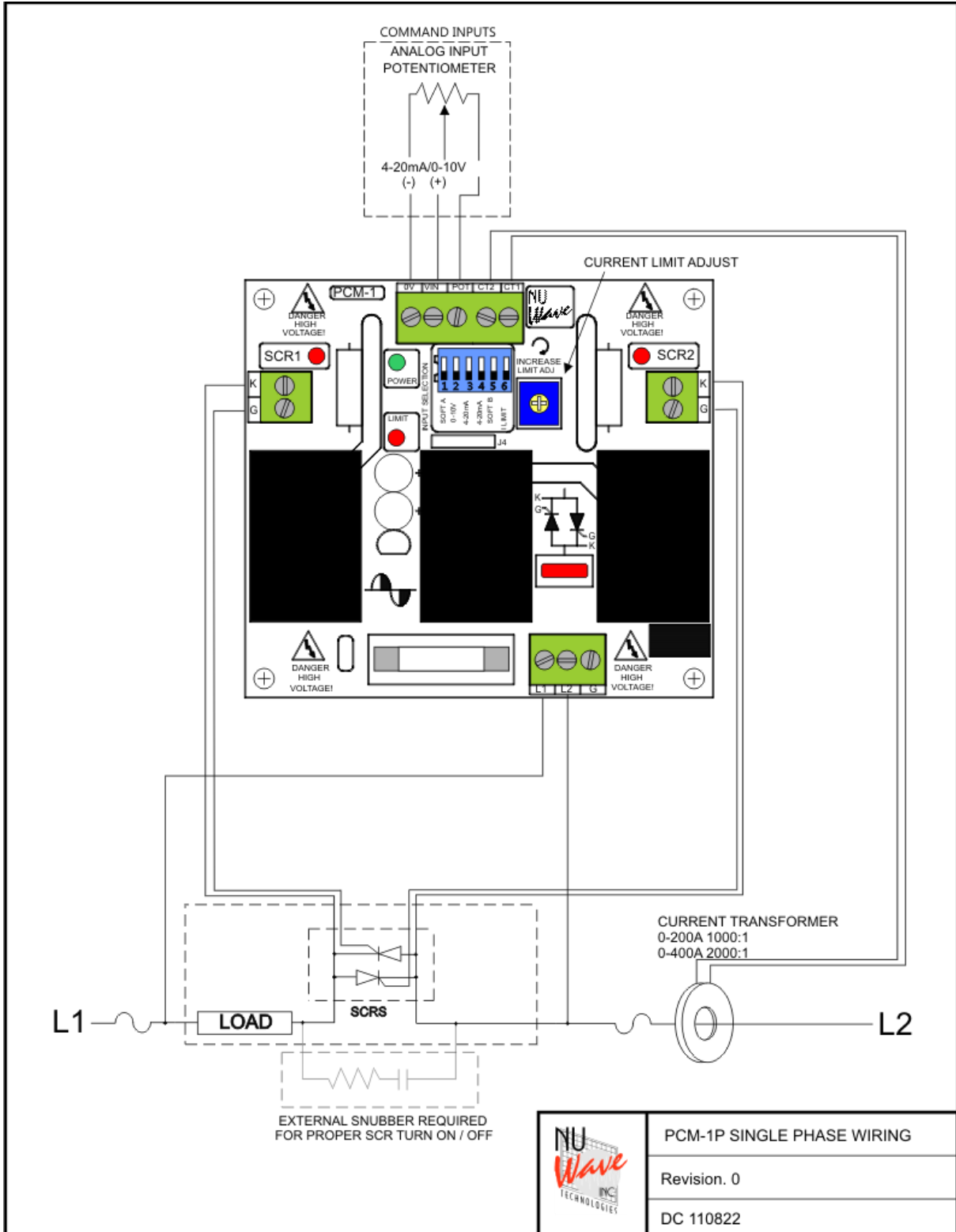

7. Contact Information

NuWave Technologies, Inc
866-379-3597
www.nuwaveproducts.com